

Introduction

Your Veeder-Root brand C628 Position Indicator is one model in a family of 1/8 DIN units which offers breakthrough display technology as well as easy-to-program single-line parameters. Designed to provide instant visual feedback regarding an application's key input value, the C628 not only has a 0.71" high LED display (27% larger than other 1/8 DIN units), but also the ability to change display color based on process status (programmable parameter in Operation Mode). Easy programming is made possible via a help function and a secondary legend display.

This manual will guide you through the installation and wiring of your C628 unit with information on proper panel mounting and rear terminal layout and wiring instructions. In addition, the instrument's operation and programming modes are thoroughly explained. The Operation Mode provides day to day operation and allows editing of preset values. The Program Mode enables the configuration of various parameters prior to initial operation. These parameters include those for basic configuration as well as other settable features which will enhance the functionality and usability of the device.

This manual also provides information on the C628 Position Indicator's alarms; transistor, relay and linear outputs; product specifications; and ordering and warranty procedures.



Features

- AWESOME 0.71" high digit LED display
- Programmable color change display based on an event
- Programmable help function and secondary legend display
- High and low alarm outputs
- Optional linear output relative to position
- Accepts encoder inputs
- Filter speed settable for 20, 200, or 10,000 Hz
- Standard outputs: two NPN transistors & one relay (optional 2nd relay)
- Front panel reset enable and alarm lockout
- Optional RS-485 plug in card
- CE approved

Index

Installation	
Panel Mounting	page 2
Wiring	page 3
Operation	
Front Panel	page 4
Operation Mode	page 5
Programming	
Program Mode	page 6-9
Appendix A	
Specifications	page 10
General	
Notes	page 11
Ordering Information	page 12
Warranty	page 12

*Technical Manual
702138-0002*

**Veeder-Root brand
Series C628
Position
Indicator
(C628-2XXX)**

INSTALLATION

PANEL MOUNTING

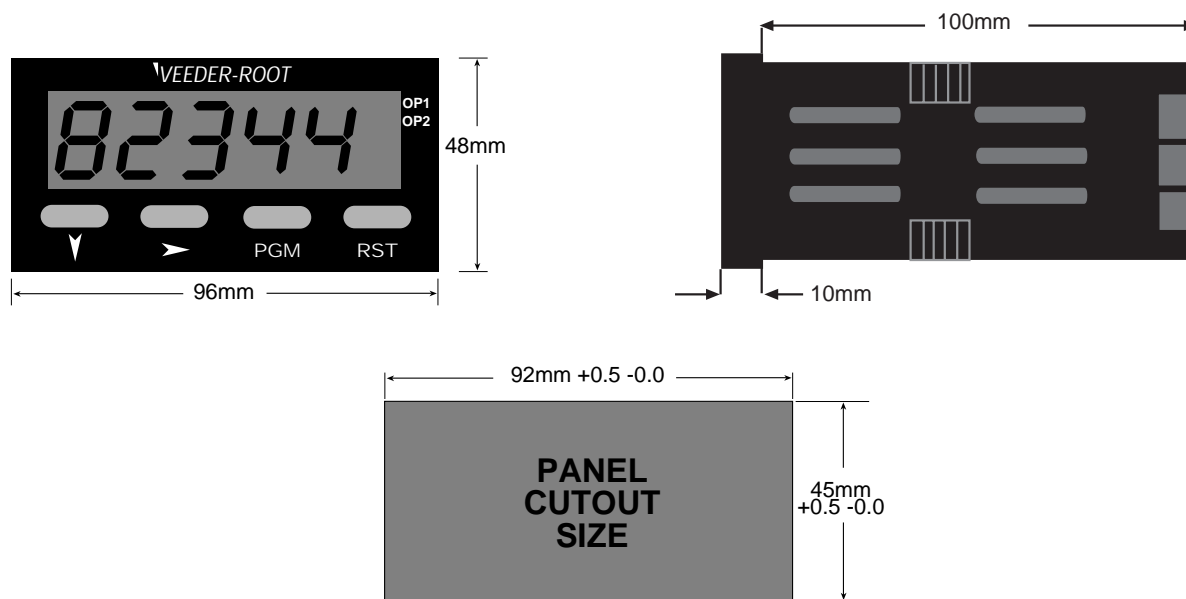

The instrument can be mounted in a panel with a thickness of up to 6mm. The cutout(s) should be made based on the recommended panel opening illustrated in the drawing above.

Mounting Grooves

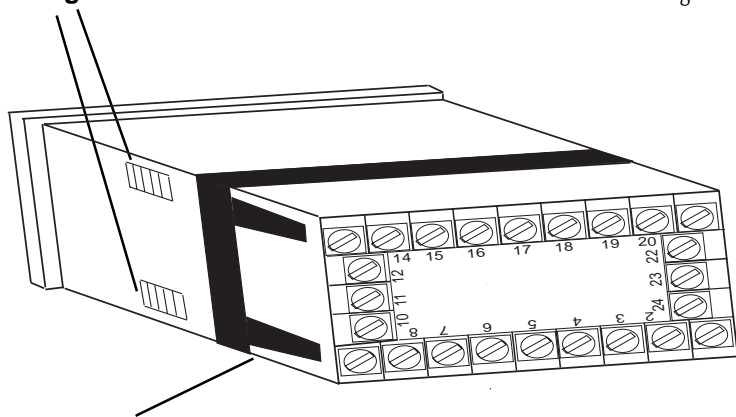

Insert the unit in the panel through the cutout. Ensure that the panel gasket is not distorted and the instrument is positioned squarely against the panel. Slide the mounting clamp into place on the instrument, as shown to the left, and push it forward until it is firmly in contact with the rear face of the mounting panel and the tabs on the bracket arm are seated in the mounting grooves on the side of the unit.

The electronic components of the instrument can be removed from the housing after installation without disconnecting the wiring. To remove the components, grip the side edges of the panel and pull the instrument forward. Take note of orientation of the unit for subsequent replacement in the housing.

Bracket Arm

WIRING

REAR TERMINAL CONNECTIONS

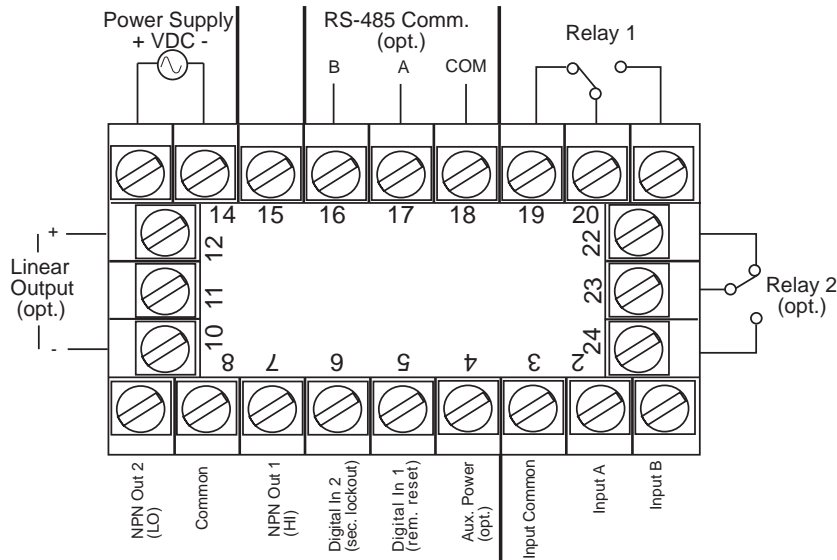

Input Power

For an AC powered unit, Terminal #13 serves as the line or Hot side connection for AC powered units and as the positive side for DC powered units. The neutral side for AC powered units and the negative side for DC powered units are connected to Terminal #14.

Count Inputs

Terminal #2 is the connection for Input A, which is used for channel A of an encoder input. Terminal #1 is the connection for Input B, which is used for channel B of an encoder input. The common connection for both Input A and Input B is Terminal #3.

Control/Digital Inputs

A contact closure or NPN signal can be used to activate preconfigured functionality. Terminal #5 is used for a remote reset function, while Terminal #6 is a security function, that when active, will prohibit entry into Program Mode. Terminal #8 serves as the common for both of these inputs.

Auxiliary Power Output

A 9 - 15 VDC for powering external sensors and encoders up to 125 mA can be accessed by connecting the positive supply side of the sensor to Terminal #4 and the negative side to Terminal #8.

Linear Output

An option board may be installed that provides a 10 bit linear output signal relative to the Position Value. Terminal #12 is the positive side of the connection, and Terminal #10 is the negative side. The default range of the output is 4-20 mA, but can be changed via the front panel to 0-20 mA, 0-10 VDC, 2-10 VDC, 0-5 VDC, or 1-5 VDC.

Transistor Outputs

Your unit comes standard with 2 NPN outputs which are activated by each of the alarms. Transistor Output 1, which is tied to the High Alarm Value, is on Terminal #7. Transistor Output 2, which is tied to the Low Alarm Value, is on Terminal #9. Terminal #8 serves as the common connection for both transistor outputs.

Relay Outputs

Your unit comes standard with a relay output which is tied to the High Alarm Value. Terminal #19 is NC, Terminal #20 is common, and Terminal #21 is NO. A second relay output tied to the Low Alarm Value can be added as an option at the time of order or later installed in the field. Terminal #22 is NC, Terminal #23 is common, and Terminal #24 is NO.

Serial Communication

An RS-485 communication board, utilizing ASCII protocol, can be installed as an option. Terminals #16 & #17 serve as the B and A connections respectively, while Terminal #18 is connected as the common.

Terminals 11 & 15 are not used.

OPERATION

FRONT PANEL

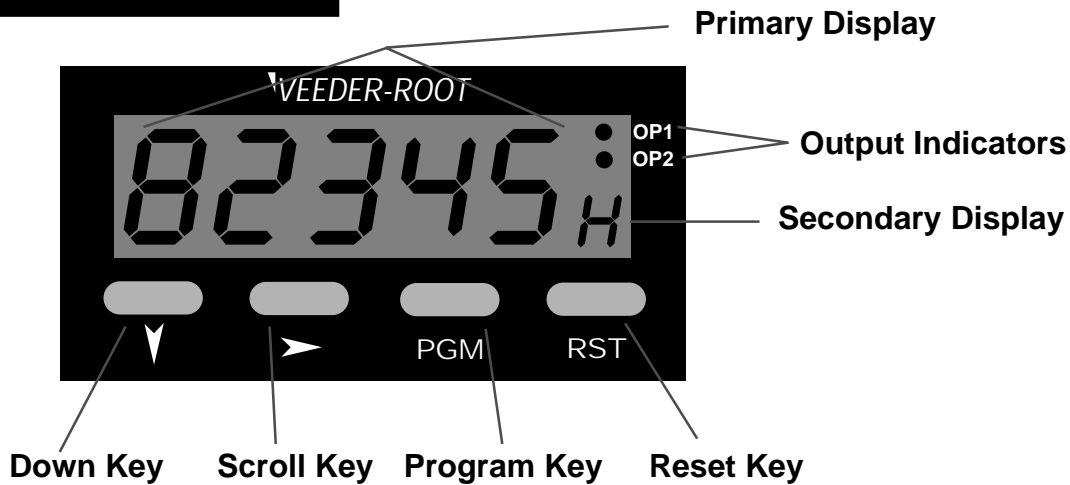

Key Functions

Key	Function
Down	<i>In Operation Mode:</i> Used in edit operation to decrement the digit highlighted by the Scroll key. <i>In Program Mode:</i> Used in Edit Operation to decrement the digit highlighted by the Scroll key, if the setting is a numerical value, or present the next in the series of choices for that parameter.
Scroll	<i>In All modes:</i> Moves the unit into Edit Operation, which is indicated by the left most digit flashing. Successive presses of the key are used to move to the digit to be edited. Wrap around will occur from least significant digit to most significant digit.
Program	<i>In Operation Mode:</i> Used to move between the position display & the alarms and to enter an edited alarm value. Holding the key down for 3 seconds will cause the unit to enter Program Mode. <i>In Program Mode:</i> Used to move from one parameter to the next and enter the edited parameter values. Holding the key down for 3 seconds will cause the unit to return to Operation Mode.
Reset	<i>In Operation Mode:</i> Resets the position display to zero (under Reset Value in Program Mode). This button can be disabled via the "Front Panel Reset Enable" parameter in Program Mode. <i>In All modes:</i> No function.
Down & Scroll together	<i>In All modes:</i> Will abort an Edit Operation and return the parameter to its previous value.

Display Functions

Display	Function
Primary	<i>In Operation Mode:</i> Default display is the position. Can be scrolled using the program key to display the alarm values. If the "Help" function is enabled, this display will first show the parameter description for 3 seconds (see page 5 for example). <i>In Program Mode:</i> Displays the value or selection for the current parameter. If the "Help" function is enabled, this display will first show the parameter description for 3 seconds (see page 6 for example).
Secondary	<i>In Operation Mode:</i> Indicates alphabetically if one of the alarms is being viewed on the primary display. This display is blank when Position is being shown. <i>In Program Mode:</i> Provides a 1 digit alpha or numeric character to indicate which parameter value is being shown on the primary display.
Output Indicators	<i>In All Modes:</i> OP1 illuminates when the High Alarm Value is reached. OP2 illuminates when the Low Alarm Value is reached.

OPERATION

OPERATION MODE

CHANGING A PRESET VALUE



Default display is the position value.



Pressing the Program Key will cause the display description to appear on the main display.* If there is no key activity for 3 seconds, the primary display will switch back to the position value.



Continued pressing of the Program Key will scroll to the Alarms. (See Parameter Sequence below.) The full parameter description will appear on the main display.*



To change a Parameter value, press the Scroll Key. If there was no key activity for 3 seconds, the Alarm value will appear (one digit description shown on secondary display); however, press the Scroll Key in order to edit. The unit will now be in Edit Operation as signified by the most significant digit flashing.**

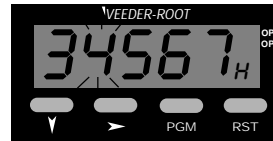

Use the Scroll Key to move from left to right and highlight the digit that needs to be changed. Wrap around will occur from the least significant to the most significant digit.

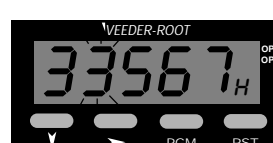

Use the Down Key to decrement the digit until the desired value appears. The display will wrap around from 0 to 9.

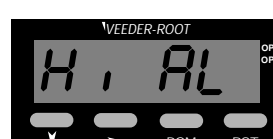

After the desired digits have been changed, press the Program Key to enter the new value. The new value will appear on the main display without any flashing digits. Press the Program Key again and the parameter description will appear on the main display.

* Parameter descriptions will not appear on the primary display if the "Help" function has been disabled.

** Edit Operation cannot be accessed if the Preset Lock has been enabled in Program Mode.

PARAMETER SEQUENCE

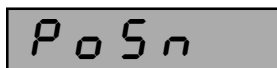

Position

Function: Displays position value

Range: -19999 to 99999



High Alarm Value

Function: Defines the position value at or above which Alarm 1 will activate

Adjustment Range: -19999 to 99999

Default Value: 1000



Low Alarm Value

Function: Defines the position value at or below which Alarm 2 will activate

Adjustment Range: -19999 to 99999

Default Value: 10

PROGRAMMING

PROGRAM MODE

ENTERING PROGRAM MODE AND BASIC OPERATION

The Program Mode can be accessed from the Operation Mode by holding the Program Key for 3 seconds.

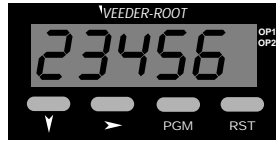

PGM for 3 seconds

The name of the first parameter will appear on the primary display.*

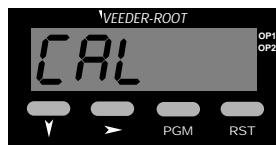

PGM

Successive presses of the Program Key will scroll the display through the remaining parameters in the Program Mode. To exit Program Mode, hold the Program Key for 3 seconds.



no key activity for 3 secs. or

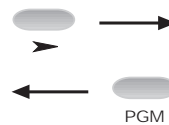

Edit Operation

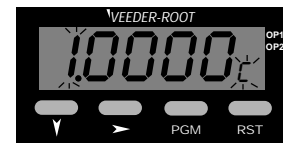

Pressing the Scroll Key or no key activity for 3 seconds will display the value for that parameter. The secondary display will indicate the one digit identifier for the parameter. The digit in the secondary display will flash to indicate the unit is in Program Mode. If the Scroll Key was pressed (instead of waiting 3 seconds), the unit is in Edit Operation, as indicated by the MSD flashing. If there had been no key activity for 3 seconds, press the scroll key to enter Edit Operation (MSD flashing). Use the scroll and edit buttons to change the value as in Operation Mode, described on page 5. Press the Program Key to enter any changes.

* Parameter names will not appear on the main display if the "Help" function has been disabled in Program Mode.

PARAMETER SEQUENCE



PGM

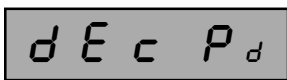

PGM

Calibration Factor

Function: Used to scale the input into engineering units by multiplying this value by the number of pulses received

Adjustment Range: 0.0001 to 9.9999

Default Value: 1.0000

Decimal Position

Function: Set the decimal point position for the position and alarm displays

Adjustment Range: 0 to 0.0000

Default Value: 0

PROGRAM MODE Continued

r E S E t S



Reset Value

Function: Defines a "home position" by selecting a value other than zero or another value within the displayed range of the device to which the counter can reset

Adjustment Range: -19999 to 99999

Default Value: 0

S P E E d F



Filter Speed

Function: Enables the debounce filter of the counter to properly match the application

Adjustment Range:

20

200

10000

20: The unit will accept up to 20 pulses per second. Generally used with contact inputs to eliminate false counts caused by contact bounce

200: The unit will accept up to 200 pulses per second. Generally used for higher speed contact inputs or to filter noise on electronic signals in low speed applications

10,000: The unit will accept up to 10,000 pulses per second. Generally used with high speed electronic inputs and encoders

Default Value: 10000

r S E n r



Front Panel Reset Enable

Function: Determines whether the Front Panel Reset key can be used to reset the position value

Adjustment Range:

En

dis

Enable: The position value can be reset while being viewed in Operation Mode by pressing the Front Panel Reset Key

Disabled: The Front Panel Reset Key is disabled and the position value can only be reset through the Remote Reset Input

Default Value: Enable

r t E n t



Retransmission Enable/Select

Function: Determines whether a voltage/current is an output, and if so, which range

Adjustment Range:

nonE

0-5V

0-10V

0-20A

4-20A

None

0-5 Volts

0-10 Volts

0-20 mA

4-20 mA

Default Value: None

PROGRAM MODE Continued

rt LoL



Retransmission Scale Minimum *(Appears only if a current/voltage is selected)*

Function: Defines the lower end of the linear scale for the retransmission output by defining the value equated to the minimum output signal - i.e. for a 4-20 mA output, this would be the value corresponding to 4 mA

Adjustment Range: -19999 to 99999

Default Value: 0

rt HiH



Retransmission Scale Maximum *(Appears only if a current/voltage is selected)*

Function: Defines the upper end of the linear scale for the retransmission output by defining the value equated to the maximum output signal - i.e. for a 4-20 mA output, this would be the value corresponding to 20 mA

Adjustment Range: -19999 to 99999

Default Value: 100

CoM75 c



Serial Communication Enabled

Function: Activates the RS-485 communication option board

Adjustment Range:

nonE

Fit

None: No communication board installed Fitted: A communication board is installed in the unit

Default Value: If ordered from the factory with the RS-485 board, the default will be "fitted". If the board is installed in the field, this parameter will need to be changed from its default of "none"

Addr A



Communication Address *(Appears only if communication board is installed and activated)*

Function: Defines the unique communication address of the unit

Adjustment Range: 1 to 99

Default Value: 1

bAud b



Baud Rate *(Appears only if communication board is installed and activated)*

Function: Selects the serial communication speed

Adjustment Range:

1200

2400

4800

9600

1200 BPS

2400 BPS

4800 BPS

9600 BPS

Default Value: 4800

PROGRAM MODE Continued

Color ◦

Display Color Change

Function: Defines the color of the display

Adjustment Range:

red

Red: The display will always be red

GrEEn

Green: The display will always be green

Gn_rd

Green to Red: The display will be green prior to the Alarm value being reached. It will turn red after the Alarm has been reached

rd_Gn

Red to Green: The display will be red prior to the Alarm value being reached. It will turn green after the Alarm has been reached



Default Value: Green to Red

Lock P

Preset Lock

Function: Determines whether the Alarm Values can be changed via the front panel

Adjustment Range:

En

Enable: Alarm values are read only

Default Value: Disable

dis

Disabled: Alarm values can be viewed and changed



HELP h

Help Prompt

Function: Determines whether the multi-character parameter name will appear on the main display for 3 seconds prior to the parameter value appearing

Adjustment Range:

HLP Y

Help - Yes: Multi-character parameter descriptions will appear on the primary display. The value associated with that parameter will appear by pressing the scroll key or waiting for 3 seconds

Default Value: Help - Yes

HLP N

Help - No: Only the parameter values will appear on the primary display. The parameter can be identified by a single digit in the secondary display

SPECIFICATIONS

Count Inputs

Type: Quadrature
 Frequency: 5 kHz max.
 Logic: Low \leq 2.0 VDC, High \geq 3.0, 30V max.
 Impedance: 10 K Ω to common - Sourcing
 4.7 K Ω to +Voltage - Sinking

Control Inputs

Type: Sinking, Edge Sensitive
 Logic: Low \leq 2.0 VDC, High \geq 3.0
 Impedance: 4.7 K Ω to +Voltage
 Response Time: 25 ms
 Function: Input 1: Remote Reset
 Input 2: Security Lockout

Outputs

Solid State: NPN open collector, 30 VDC max, 100 mA max.
 Relay: SPDT, 5A resistive @ 110VAC
 Latency: 75 μ seconds, plus 8 ms for relay pull-in

Linear Outputs

Ranges: 0-20mA, 4-20mA, 0-10V, 2-10V, 0-5V, 1-5V
 Accuracy: \pm 0.25% (mA at 250 Ω , V at 2k Ω);
 degrades linearly to \pm 0.5%
 Resolution: 8 bits in 250ms (10 bits in 1s typ.)
 Update: Approximately 4/s
 Load Impedence: mA Ranges: 500 Ω max.; V Ranges: 500 Ω min.

Approvals

General: CE
 EMC Susceptibility: Complies with EN50082-1: 1992,
 EN50082-2: 1995
 EMC Emissions: Complies with EN50081-1: 1992,
 EN50081-2: 1994
 Safety: Complies with EN61010-1: 1993

Communication

Type: Serial asynchronous, UART to UART
 Data Format: Open ASCII: One start bit, even parity seven
 data bits, one stop bit
 Physical Layer: RS-485
 Maximum Zones: 99
 Baud Rate: Selectable from 9600, 4800, 2400, or 1200

Electrical

Supply Voltage: 90-264 VAC, 50/60 Hz, or 20-50 VAC/VDC
 Power Consumption: 4 Watts
 Access. Power Supply: 9-15 (unregulated VDC), 125 mA max.

Display

Type: Red/Green, 7 segment LED, 5 digits primary
 display, single digit secondary display
 Height: 0.71" (18mm) primary display,
 0.3" (7mm) secondary display
 Annunciators: Output 1 & 2 status

Physical

Dimensions: 48mm x 96mm, 110mm deep
 Mounting: Panel mount (mounting bracket supplied),
 45mm x 92mm cutout
 Terminals: Screw type - combination head
 Front Panel Rating: NEMA 4X/IEC IP65
 Case Material: GE Lexan 940
 Weight: 0.56 lbs.

Environmental

Operating Temp.: 0° to 55° Celsius, 32° to 131° Fahrenheit
 Storage Temp.: -20° to 80° Celsius, -4° to 176° Fahrenheit
 Relative Humidity: 20% to 95% non-condensing

GENERAL

NOTES

ORDERING INFORMATION

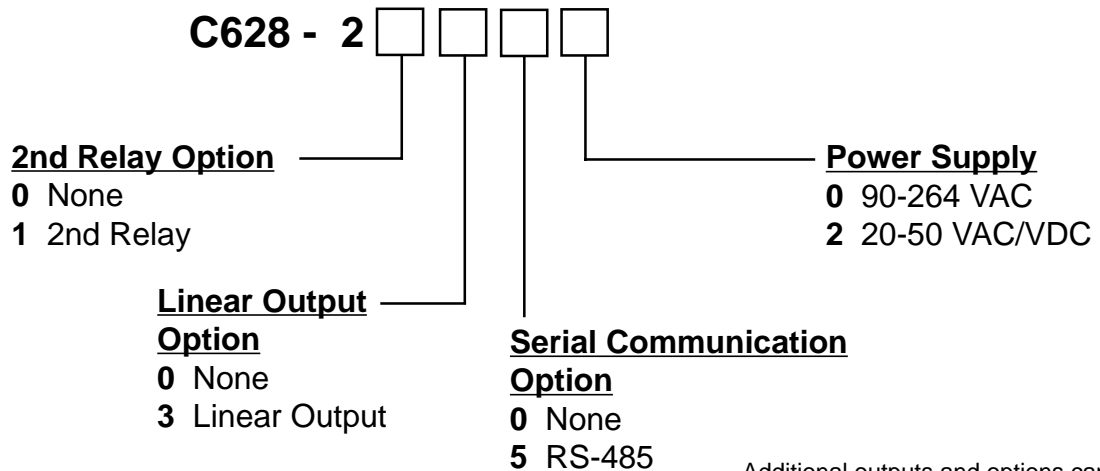

Additional outputs and options can be field installed through plug-in boards which can be ordered separately.

Description	Part #
Relay Board	T50-001
DC Linear Board	T50-003
RS-485 Comm. Board	T50-005

WARRANTY

Standard products manufactured by the Company are warranted to be free from defects in workmanship and material for a period of one year from the date of shipment, and products which are defective in workmanship or material will be repaired or replaced, at the option of the Company, at no charge to the Buyer. Final determination as to whether a product is actually defective rests with the Company. The obligation of the Company hereunder shall be limited solely to repair and replacement of products that fall within the foregoing limitations, and shall be conditioned upon receipt by the Company of written notice of any alleged defects or deficiency promptly after discovery within the warranty period, and in the case of components or units purchased by the Company, the obligation of the Company shall not exceed the settlement that the Company is able to obtain from the supplier thereof. No products shall be returned to the Company without its prior consent. Products which

the Company consents to have returned shall be shipped F.O.B. the Company's factory. The Company cannot assume responsibility or accept invoices for unauthorized repairs to its components, even though defective. The life of the products of the Company depends, to a large extent, upon the type of usage thereof, and THE COMPANY MAKES NO WARRANTY AS TO FITNESS OF ITS PRODUCTS FOR SPECIFIC APPLICATIONS BY THE BUYER NOR AS TO PERIOD OF SERVICE UNLESS THE COMPANY SPECIFICALLY AGREES OTHERWISE IN WRITING AFTER THE PROPOSED USAGE HAS BEEN MADE KNOWN TO IT.

THE FOREGOING WARRANTY IS EXCLUSIVE AND IN LIEU OF ALL OTHER WARRANTIES EXPRESSED OR IMPLIED, INCLUDING, BUT NOT LIMITED TO ANY WARRANTY OF MERCHANTABILITY OR OF FITNESS FOR A PARTICULAR PURPOSE.



1675 Delany Road
 Gurnee, IL 60031-1282
 Phone: 847.662.2666
 Fax: 847.662.6633

Printed in U.S.A.
 702138-0002
 March 1998
 Revision none